

Digi-Zone Adder

Model MDPA2 Ver.04

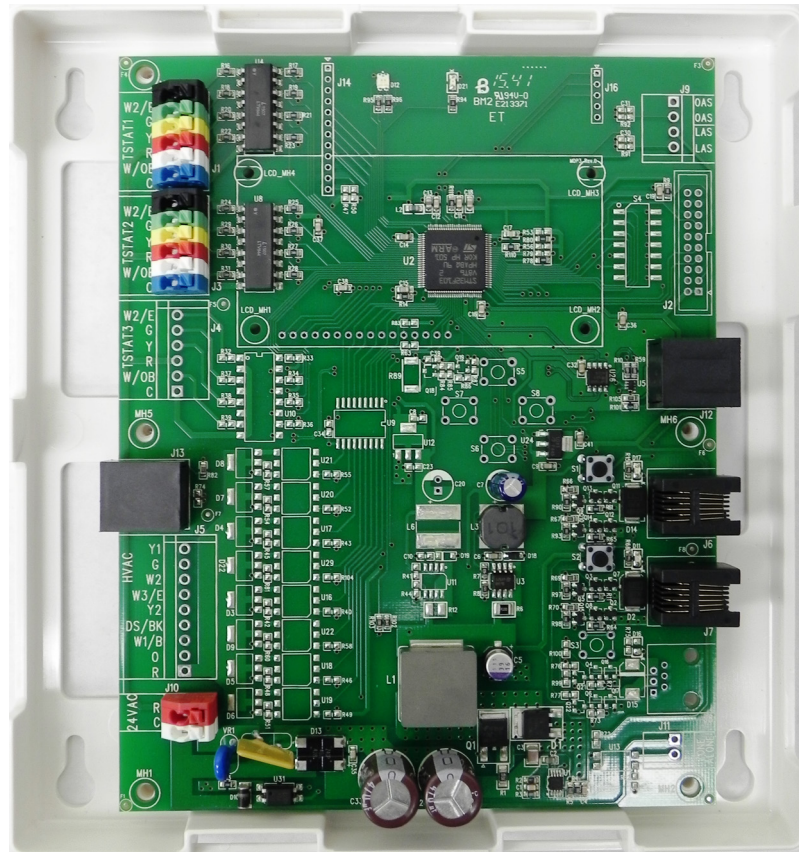

Installation and Operating Instructions

ZONEFIRST[®]

Controlling Your Comfort Room By Room

MDPA2 Panel Features

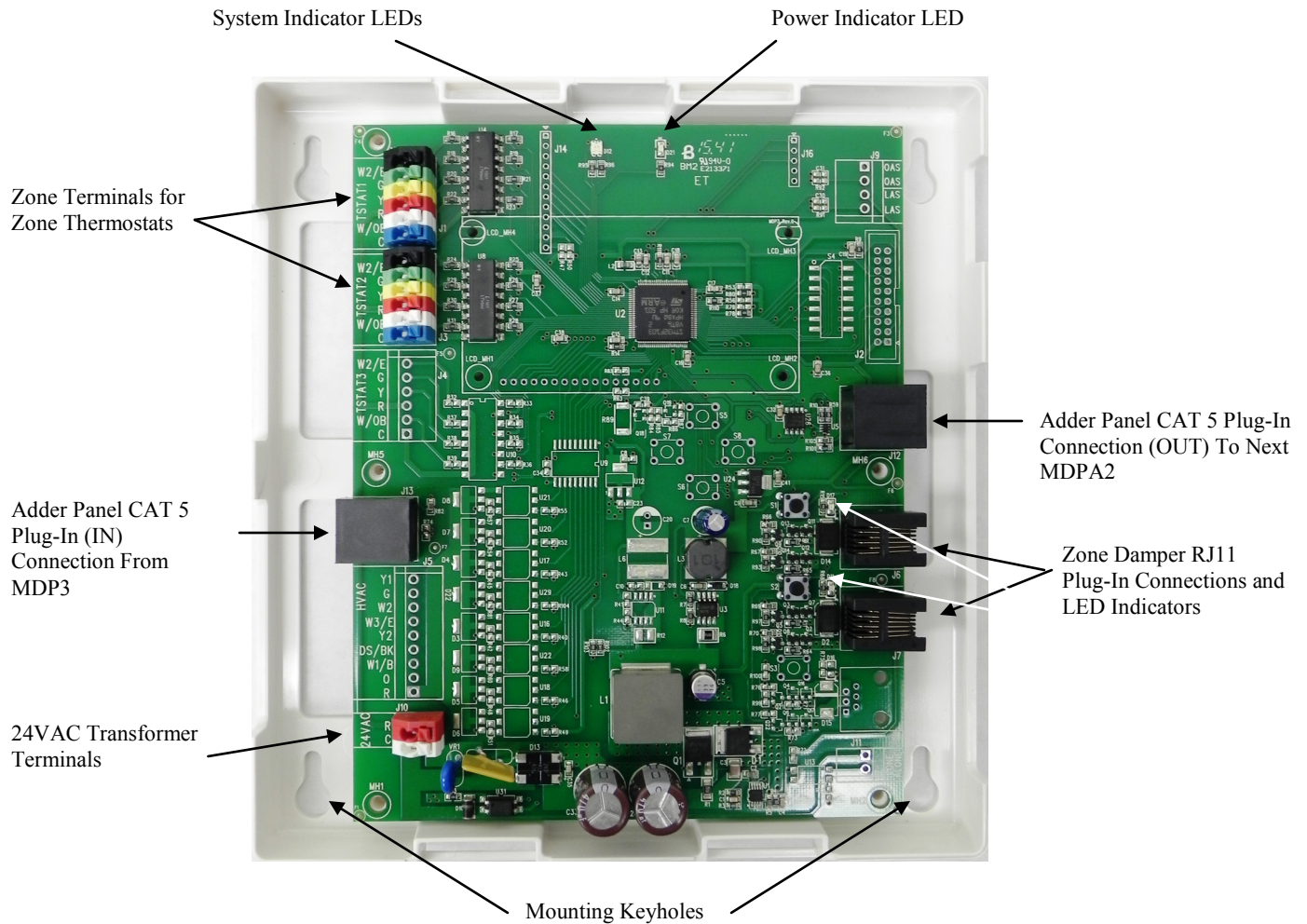

Table of Contents

Installation	2
Operation	3
Wiring	3
Checkout	3
Troubleshooting	4

INSTALLATION

The Digi-Zone Adder (MDPA2) for Plug-In Dampers is a two (2) zone control panel that is only used to add one or two additional zones to the MDP3 Zone Panel. A total of fifty (50) MDPA panels may be added to an MDP3 Zone Panel to get up to one hundred and three (103) zones.

When installing the MDPA2 panel it is important to pick a central location (typically in close proximity to the MDP3 control panel) where it is most convenient to bring all the wires. Most often this is at the furnace or air handler. It is often closest to power, the HVAC unit

controls and the zone dampers when typically located at or near the plenum. However this panel can be located remotely from the main panel and only requires a CAT 5 cable (supplied with MDPA2) in order to place remotely.

The MDPA2 panel case is made of sturdy ABS plastic and can be mounted to any flat surface. It is recommended that the panel be mounted to a wall or return plenum and NOT on the furnace or plenum where it will be in contact with the hot temperatures.. The panel can be located in an attic space or in an enclosed cabinet of a rooftop unit. Insure the panel is not in direct exposure to the elements.

The cover easily removes from the case by pulling firmly and separating the cover from the case exposing the circuit board. There are 4 key-hole mounting points in each corner of the case. The case has openings in the rear of the case as well as the side for all wiring. Wiring can come from the back as well as the side in order to make a neat installation.

OPERATION

The MDPA2 is an extension of the MDP3 zone functions. The MDPA2 must use the same thermostat wiring configuration as the zones on the MDP3. The MDPA2 is not used as a stand alone panel.

On a call for heating or cooling, the panel will accept the first call from any zone, providing no other calls for heating or cooling exist in the system. Upon accepting this call the MDPA2 will open its zone damper(s), if not open already, close the damper(s) to those zones not calling, activate the needed HVAC controls for heating or cooling, whichever is being called and not accept any calls for the opposite mode.

Any calls for the opposite mode will be locked out until the initial mode is either satisfied or a period of time has elapsed that is sufficient for the first mode to satisfy, a maximum of 20 minutes. A Patent Pending sequence determines the time the unit has been running or needs to continue to run in order to adequately provide conditioning for each mode. If a particular mode has already been calling for 20 minutes or longer and an opposite call comes in the MDPA2 will immediately drop the mode, enter the purge mode in order to dissipate the conditioned air into the zones calling before switching over to provide the new conditioning call to its zones.

All other functions are identical to the MDP3 zone operation, see the MDP3 installation and operating instructions for further details.

WIRING

The MDPA2 is very simple to wire and requires only a minimum number of connections. The MDPA2 color coded terminal blocks are screw-less and all wires can easily be pushed into their respective terminal by de-pressing the button for each point and releasing once the wire is seated. To remove the wire, just press it's button again and remove the wire.

Zone Dampers – The MDP3 provides DC power to ZONEFIRSTS' exclusive Plug-In Zone Dampers. These dampers use and are supplied with a modular cord that is complete with RJ11 jacks on each end of a 25' cable for each zone damper. Up to 10 dampers can be wired to each zone.

The panel has a GREEN LED to indicate when the damper should be open. Each damper motor has a two color LED that a positive indication of the damper being open or closed. When the LED is GREEN the damper is Open. When the LED is RED the damper is closed.

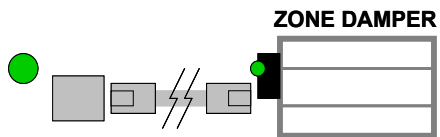

WIRING DIAGRAM 1 – Conventional Thermostat

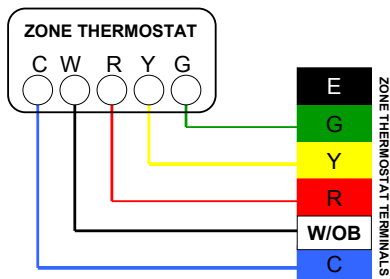

WIRING DIAGRAM 2 – Heat Pump Thermostat

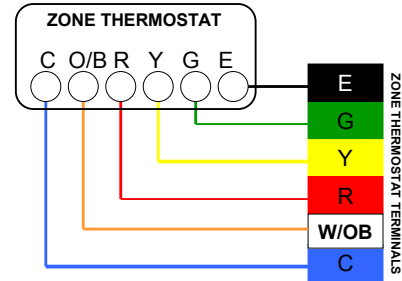

Zone Adder Connection – The MDPA2 panel communicates with the MDP3 using a CAT 5 cable. A four (4') foot CAT 5 cable is supplied with each MDPA2 panel. This cable is connected to the modular plug on the left side of the MDPA2 panel and the other end connected to the connector on the right side of the MDP3 panel. Up to 50 additional MDPA2 panels are connected in the same way in a daisy chain from one MDPA2 panel to the next.

Transformer – A 24VAC, 40VA transformer is required to power the panel. This transformer is wiring to the 24VAC: C and 24VAC: R terminals on the lower left corner of the panel. Before wiring to the MDPA2 panel, check the phasing of this transformer with the transformer that powers the MDP3 panel. Ensure that both transformers are in phase with one another. See directions on page 4.

CHECKOUT

The MDPA2 has unique features that simplify the checkout of the system and has LED readouts that constantly indicate the system operation.

POWER LED is constantly illuminated **GREEN** when 24VAC is applied to the MDPA2. The power LED will flash green when the MDP3/MDPA2 is in the test mode.

HEAT LED is constantly illuminated **RED** when MDP3/MDPA2 is calling for the first stage of heating, will flash two times (2X) when second stage heat energizes and will flash three times (3X) when the third stage of heat or emergency heat is energized.

COOL LED is constantly illuminated **GREEN** when the MDP3/MDPA2 is calling for the first stage of cooling and will flash two times (2X) when the second stage of cooling is energized.

FAN LED is constantly illuminated **YELLOW** when calling for the fan or when the compressor is running.

ZONE DAMPER LEDs will constantly be illuminated **GREEN** when no zone is calling and indicating the zone dampers are in the open position.. When a zone calls for heating, cooling or fan that zone LED will remain illuminated and those zones not calling the LED will go out, indicating that the zone dampers are in the closed position

TROUBLESHOOTING

The MDPA2/MDP3 is a very simple control to troubleshoot, especially with the LED indicators. The only other device needed is a simple Volt/Ohm meter. Almost all problems can be traced to an external component or wiring to/from the MDPA2. The following procedures can help isolate the problem.

Zone(s) Not Calling

Each zone has a LED next to the zone damper plug-in jack, when a zone is calling and that call is being recognized by the MDPA2/MDP3 that zone LED will be illuminated GREEN. Provided no other zone is calling for the opposite mode, check the zone that is supposed to be calling and the zone's LED. If it is not on, check for 24VAC across the thermostat terminal C and the Y, if a Cool call, W if a Heat Call, or G if a Fan call. If there is no voltage here at the panel, the panel is not getting the signal from the thermostat. The problem is mis-wiring, a broken wire or a problem in the thermostat. To check the zone on the panel, place jumper from R to Y, R to W or R to G to see that the panel is operating properly.

Zone(s) Will Not Shut Off

If a zone will not stop calling, the Zone LED should still be illuminated GREEN. Depending on the call disconnect the Y, W or G wire from the terminal strip. The zone will drop out. Check the thermostat wiring for a mis-wiring or short that keeps the zone calling. If the call remains and the thermostat is disconnected, replace the panel.

Damper Motor Checkout

To checkout the dampers, the panel has a LED for each zone. This illuminates GREEN when the dampers are to be OPEN, either on a call or when all zones are satisfied. The damper position is confirmed by the bi-color LED on the motor. When the panel zone LED is Green, the motor LED must be Green also indicating the damper being open. When the panel LED is not lit the damper should be closed and this is confirmed by the damper LED being Red.

Power LED Not On

If the Power LED is not illuminated GREEN and there is 24VAC at the transformer terminals, the MDPA has a built-in thermal fuse, (light brown rectangle component below transformer terminals) that may be open. To check, touch to see if component is hot. If it is hot, fuse is open and must be reset. This is also indicative of a potential wiring short.

Remove all wires (start with transformer wires) from the MDPA2 panel and check fuse (must be cool to the touch) to make sure it is not hot. Place 24VAC wires back to transformer terminals on panel and power LED should come back on. If it does not, replace board. If it does light, begin adding the wires from each zone to the panel one by one checking the power LED at each point. If the power LED drops again check these wires for a potential short.

TRANSFORMER PHASING

When using separate transformers to power the MDP3 and MDPA2 panels it is required that all transformers be in phase with one another. To check the transformer phasing use a voltmeter and check for voltage on one leg of the 24V transformer connection on the MDP3 panel to the opposite leg of the 24V transformer connection on the MDPA2 panel. See the diagram below. The voltmeter should read zero (0) Volts. If the voltmeter reads 24V or 48V, reverse the leads of one of the transformer until the voltmeter reads zero (0) volts. Reading zero volts proves the transformers are in phase with one another.

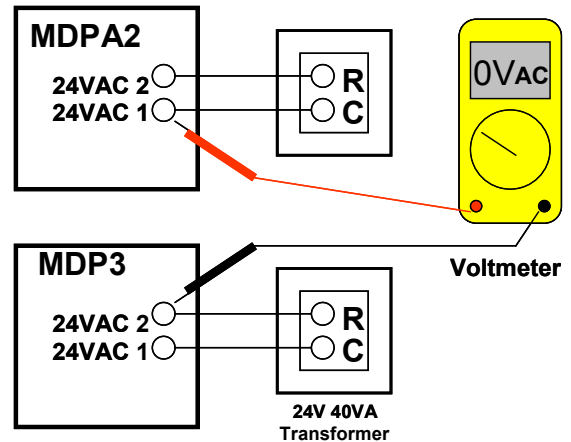

MDPA2 Panel Wiring Diagram

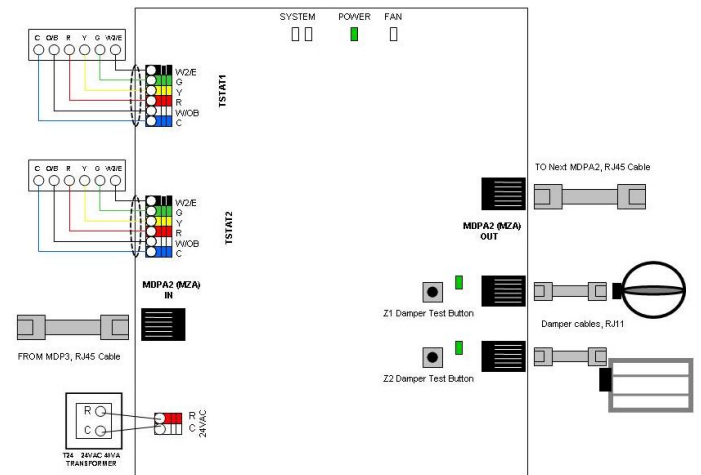

20 Bushes Lane • Elmwood Park, New Jersey 07407-3204
USA

Telephone 1.877.604.1044 FAX 1.201.794.1359
www.zonefirst.com info@zonefirst.com